

TITLE	KADOMILESS KANTOUCH
MODEL	JH8-1/4-B-N-Ro

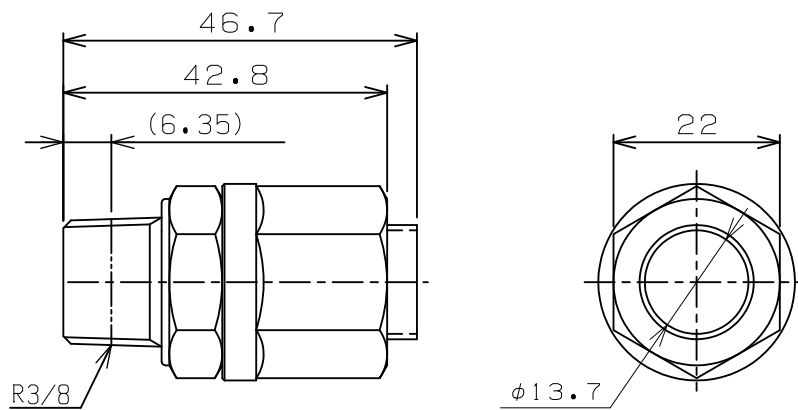

TITLE	KADOMILESS KANTOUCH
MODEL	JH8-3/8-B-N-Ro

JH8-B-N-Ro	RGL JOINT CO., LTD
------------	--------------------

DATE	08, 02, 27	A4	1/1
------	------------	----	-----