

リングP6

TITLE	KANTOUCH
MODEL	TH4-1/8-BorS

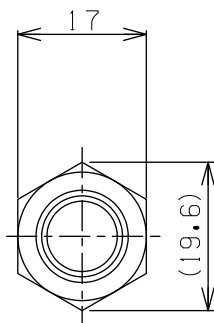
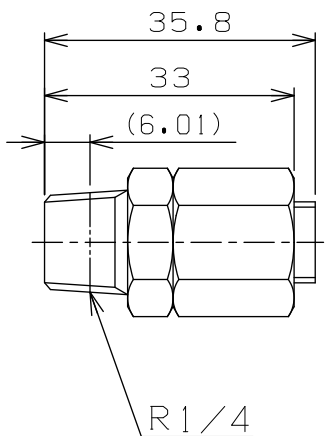

リングP6

TITLE	KANTOUCH
MODEL	TH4-1/4-BorS

TH4-BorS		RGL JOINT CO., LTD	
DATE	08, 03, 31	A4	1/1