

TITLE	KADOMILESS KANTOUCH
MODEL	THJ8-1/4-B-N-R _o

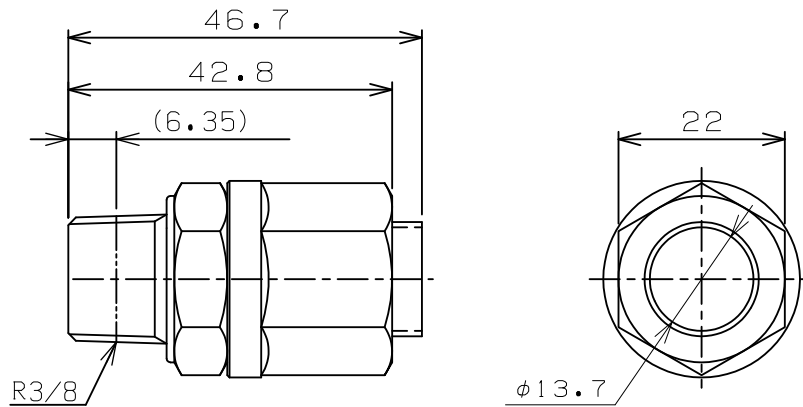

TITLE	KADOMILESS KANTOUCH
MODEL	THJ8-3/8-B-N-R _o

THJ8-B-N-R _o	RGL JOINT CO., LTD
-------------------------	--------------------

DATE	08, 02, 27	A4	1/1
------	------------	----	-----