

※ 受注生産品になります。詳細はお問い合わせください。

R-4

ストリートエルボ

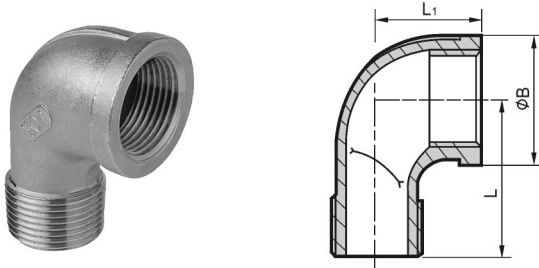

型式:R-4 単位:mm

SIZE	φB	L	L1
1/8"	17.0	25.0	19.0
1/4"	21.0	28.3	21.0
3/8"	25.0	32.0	25.0
1/2"	29.0	42.0	28.0
3/4"	35.0	50.5	33.0
1"	43.0	52.0	39.0
1-1/4"	52.0	60.0	45.0
1-1/2"	58.8	65.0	50.0
2"	71.7	74.0	58.0

R-5

45°エルボ

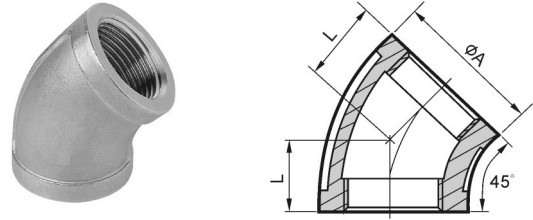

型式:R-5 単位:mm

SIZE	φA	L
※ 1/8"	18.0	18.0
1/4"	21.0	19.4
3/8"	25.0	20.0
1/2"	29.5	22.0
3/4"	35.6	25.0
1"	43.0	28.0
※ 1-1/4"	52.4	33.0
※ 1-1/2"	58.0	36.0
※ 2"	72.0	43.0

R-4A

45°ストリートエルボ

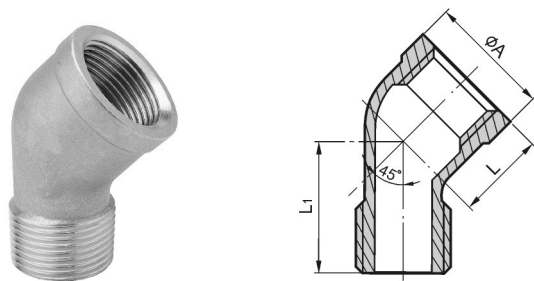

型式:R-4A 単位:mm

SIZE	φA	L	L1
1/8"	17.0	16.0	21.0
1/4"	21.0	17.0	23.0
3/8"	25.0	19.0	27.0
1/2"	29.0	21.0	31.0
3/4"	35.0	25.0	36.0
1"	43.0	29.0	42.0
※ 1-1/4"	52.0	34.0	49.0
※ 1-1/2"	58.0	37.0	51.0
※ 2"	71.0	42.0	59.0

R-6

メス×メスユニオン(面シール)

R-6A

メス×メスユニオン(PTFEガスケット)

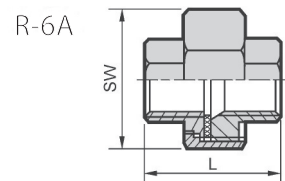
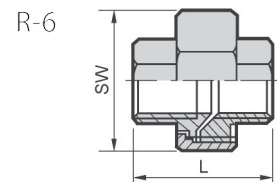
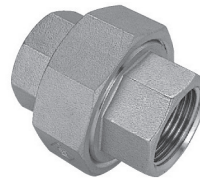

型式:R-6 単位:mm

SIZE	L	SW
※ 1/8"	29.0	25.0
※ 1/4"	37.5	30.0
※ 3/8"	38.0	35.0
※ 1/2"	42.0	42.0
※ 3/4"	50.4	47.0
※ 1"	48.0	53.0
※ 1-1/4"	59.0	71.0
※ 1-1/2"	65.0	78.0
※ 2"	69.0	92.0

型式:R-6A 単位:mm

SIZE	L	SW
※ 1/8"	29.0	25.0
※ 1/4"	38.0	30.0
※ 3/8"	37.0	35.0
※ 1/2"	42.0	42.0
※ 3/4"	50.4	47.0
※ 1"	48.0	53.0
※ 1-1/4"	59.0	71.0
※ 1-1/2"	64.0	78.0
※ 2"	69.0	92.0

※ 受注生産品になります。詳細はお問い合わせください。

R-6B オス×メスユニオン(面シール)

R-6C オス×メスユニオン(PTFEガスケット)

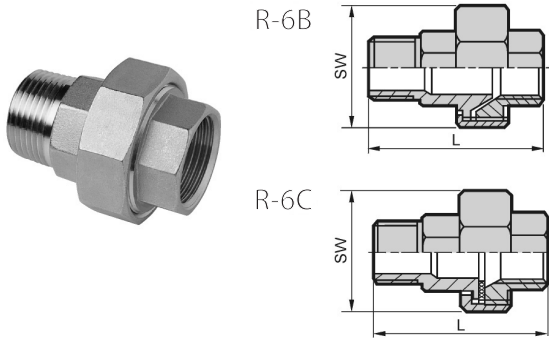

型式:R-6B 単位:mm

SIZE	L	SW
1/8"	40.0	25.0
1/4"	50.0	30.0
3/8"	50.0	35.0
1/2"	58.0	42.0
3/4"	67.0	47.0
1"	68.3	53.0
1-1/4"	83.0	71.0
1-1/2"	86.3	78.0
2"	94.0	92.0

型式:R-6C 単位:mm

SIZE	L	SW
1/8"	41.0	25.0
1/4"	50.0	30.0
3/8"	50.0	35.0
1/2"	58.0	42.0
3/4"	67.0	47.0
1"	69.0	53.0
1-1/4"	83.0	71.0
1-1/2"	87.0	78.0
2"	95.0	92.0

R-7A 径違い六角ニップル

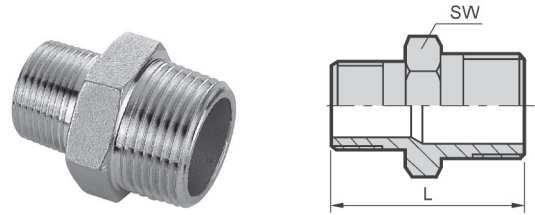

型式:R-7A 単位:mm

SIZE	L	SW
1/4"×1/8"	34.0	18.0
3/8"×1/8"	35.0	21.0
3/8"×1/4"	34.0	21.0
1/2"×1/8"	34.0	26.0
1/2"×1/4"	34.0	26.0
1/2"×3/8"	41.0	26.0
3/4"×1/8"	37.0	30.0
3/4"×1/4"	37.0	30.0
3/4"×3/8"	37.0	30.0
3/4"×1/2"	45.0	30.0
1"×1/8"	39.0	35.0
1"×1/4"	39.0	35.0
1"×3/8"	40.0	35.0
1"×1/2"	43.2	35.0
1"×3/4"	50.0	37.0
1-1/4"×1/4"	45.0	46.0
1-1/4"×3/8"	46.0	46.0
1-1/4"×1/2"	48.0	46.0
1-1/4"×3/4"	52.0	46.0
1-1/4"×1"	54.0	46.0
1-1/2"×3/8"	48.0	50.0
1-1/2"×1/2"	49.0	50.0
1-1/2"×3/4"	53.0	50.0

型式:R-7A 単位:mm

SIZE	L	SW
1-1/2"×1"	53.0	50.0
1-1/2"×1-1/4"	59.0	50.0
2"×1/2"	52.0	63.0
2"×3/4"	56.0	63.0
2"×1"	57.0	63.0
2"×1-1/4"	58.0	63.0
2"×1-1/2"	65.4	64.0

R-72 六角ニップル

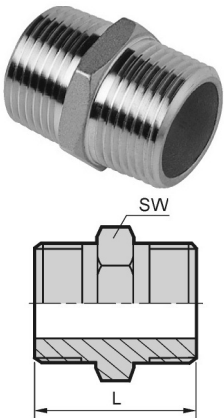

型式:R-72(NPT/PT) 単位:mm

SIZE	L	SW
1/8"	29.0	12.0
1/4"	32.5	17.0
3/8"	36.0	20.0
1/2"	42.5	26.0
3/4"	46.0	32.0
1"	51.5	38.0
1-1/4"	56.0	46.0
1-1/2"	60.0	52.5
2"	65.0	62.0

R-7B 両長ニップル

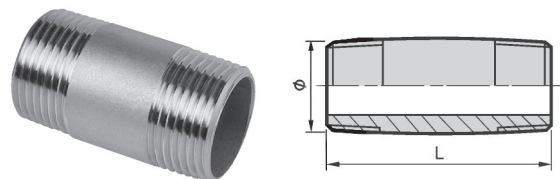

型式:R-7B 単位:mm

SIZE	φ	L
1/8"	10.4	50 / 75 / 100 / 125 / 150 / 200
1/4"	13.8	50 / 75 / 100 / 125 / 150 / 200
3/8"	17.3	50 / 75 / 100 / 125 / 150 / 200
1/2"	21.7	50 / 75 / 100 / 125 / 150 / 200
3/4"	27.1	50 / 75 / 100 / 125 / 150 / 200
1"	34.0	50 / 75 / 100 / 125 / 150 / 200
1-1/4"	42.8	75 / 100 / 125 / 150 / 200
1-1/2"	48.5	75 / 100 / 125 / 150 / 200
2"	60.5	75 / 100 / 125 / 150 / 200

■ 受注生産品